

Spec Sheet STP380600090C

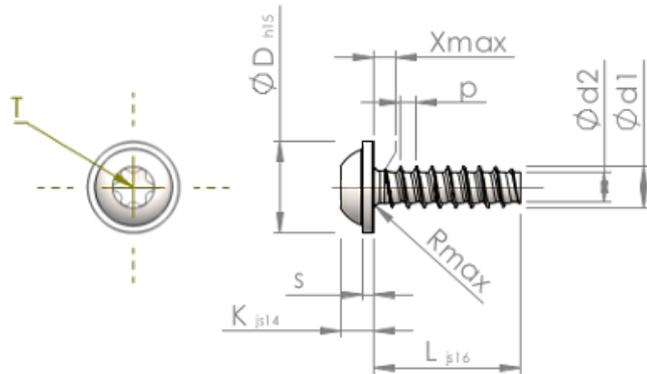

Item Number		STP380600090C
Standard		KN6038
Material		stainless steel A4
Surface		bright, pickled and passivated
Thread Outside-Ø	d1	6.00 ^{+0.15} mm
Thread Core-Ø	d2	4.26 mm
Thread Pitch	p	2.14 mm
Length	L	9.00 ±0.45 mm
Head-Ø	D	13.50 _{-0.70} mm
Head Height	K	4.200 ±0.150 mm
Flange Thickness	S	1.40 mm
Thread Run-Out	X	3.00 mm
Radius	R	0.80 mm
Size Six Lobe		T30
Penetration Depth	t	1.90 - 2.40 mm
Thread		STS-plus
Weight		3.617 kg / 1000 pieces
Customs Tariff No		73 181 410