

Technische gegevens
STP380500380S

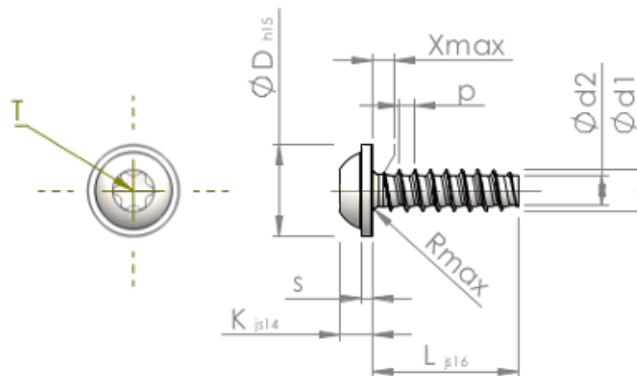

Produktnummer		STP380500380S
Norm		KN6038
Materiaal		veredeld staal
Oppervlak		verzinkt 5-7 μm , getempert, blauw / transparant gepassiveerd
Schroefdraad buiten- \varnothing	d1	5.00 $^{+0.15}$ mm
Schroefdraad kern- \varnothing	d2	3.53 mm
Spoed	p	1.80 mm
Lengte	L	38.00 ± 0.80 mm
Kop- \varnothing	D	11.00 $_{-0.70}$ mm
Kop hoogte	K	3.500 ± 0.150 mm
Flensdikte	S	1.20 mm
Draaduitloop	X	2.50 mm
Radius	R	0.70 mm
TX		T25
Indringdiepte	t	1.50 - 1.90 mm
Draad		STS-plus
Gewicht		4.985 kg / 1000 stuk
Douane tarief nummer		73 181 499