

Spec Sheet STP380500350C

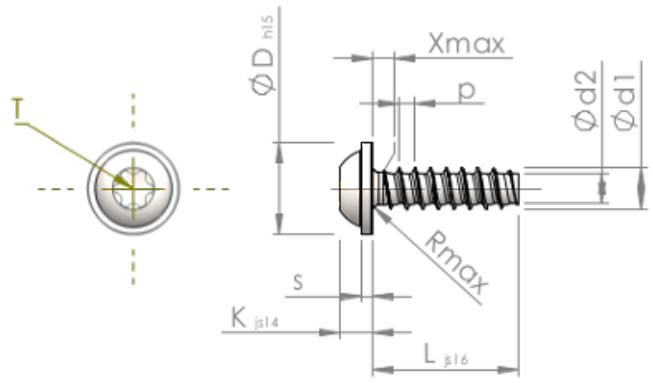

Item Number		STP380500350C
Standard		KN6038
Material		stainless steel A4
Surface		bright, pickled and passivated
Thread Outside-Ø	d1	5.00 ^{+0.15} mm
Thread Core-Ø	d2	3.53 mm
Thread Pitch	p	1.80 mm
Length	L	35.00 ±0.80 mm
Head-Ø	D	11.00 _{-0.70} mm
Head Height	K	3.500 ±0.150 mm
Flange Thickness	S	1.20 mm
Thread Run-Out	X	2.50 mm
Radius	R	0.70 mm
Size Six Lobe		T25
Penetration Depth	t	1.50 - 1.90 mm
Thread		STS-plus
Weight		4.701 kg / 1000 pieces
Customs Tariff No		73 181 410