

Spec Sheet STP380500250C

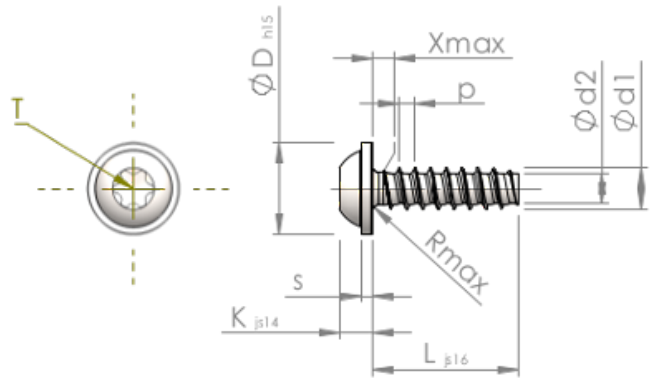

Item Number		STP380500250C
Standard		KN6038
Material		stainless steel A4
Surface		bright, pickled and passivated
Thread Outside-Ø	<b>d1</b>	5.00 <sup>+0.15</sup> mm
Thread Core-Ø	<b>d2</b>	3.53 mm
Thread Pitch	<b>p</b>	1.80 mm
Length	<b>L</b>	25.00 ±0.65 mm
Head-Ø	<b>D</b>	11.00 <sub>-0.70</sub> mm
Head Height	<b>K</b>	3.500 ±0.150 mm
Flange Thickness	<b>S</b>	1.20 mm
Thread Run-Out	<b>X</b>	2.50 mm
Radius	<b>R</b>	0.70 mm
Size Six Lobe		T25
Penetration Depth	<b>t</b>	1.50 - 1.90 mm
Thread		STS-plus
Weight		3.755 kg / 1000 pieces
Customs Tariff No		73 181 410