

Technische gegevens
STP380500200E

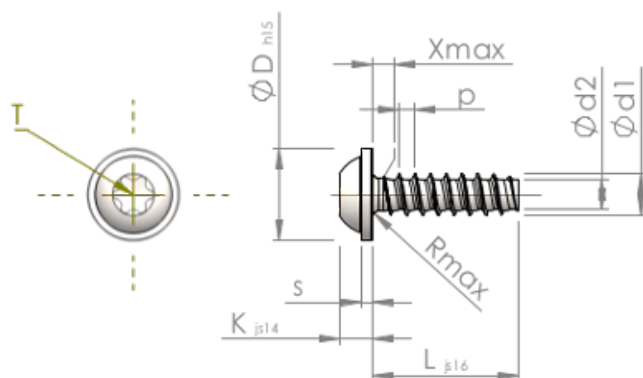

Produktnummer		STP380500200E
Norm		KN6038
Materiaal		roestvrij staal A2
Oppervlak		blank, geetst en gepassiveerd
Schroefdraad buiten-Ø	d1	5.00 ^{+0.15} mm
Schroefdraad kern-Ø	d2	3.53 mm
Spoed	p	1.80 mm
Lengte	L	20.00 ±0.65 mm
Kop-Ø	D	11.00 _{-0.70} mm
Kop hoogte	K	3.500 ±0.150 mm
Flensdikte	S	1.20 mm
Draaduitloop	X	2.50 mm
Radius	R	0.70 mm
TX		T25
Indringdiepte	t	1.50 - 1.90 mm
Draad		STS-plus
Gewicht		3.282 kg / 1000 stuk
Douane tarief nummer		73 181 410