

Technische gegevens
STP380450450S

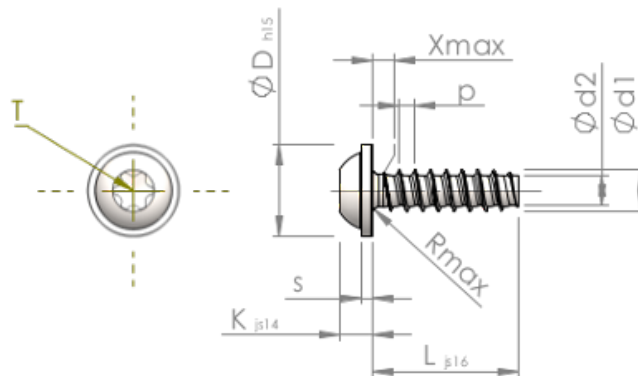

Produktnummer		STP380450450S
Norm		KN6038
Materiaal		veredeld staal
Oppervlak		verzinkt 5-7 μm , getempert, blauw / transparant gepassiveerd
Schroefdraad buiten- \varnothing	d1	4.50 $^{+0.10}$ mm
Schroefdraad kern- \varnothing	d2	3.17 mm
Spoed	p	1.63 mm
Lengte	L	45.00 ± 0.80 mm
Kop- \varnothing	D	10.00 $_{-0.58}$ mm
Kop hoogte	K	3.200 ± 0.150 mm
Flensdikte	S	1.10 mm
Draaduitloop	X	2.30 mm
Radius	R	0.60 mm
TX		T20
Indringdiepte	t	1.40 - 1.80 mm
Draad		STS-plus
Gewicht		4.472 kg / 1000 stuk
Douane tarief nummer		73 181 499