

Spec Sheet STP380450180S

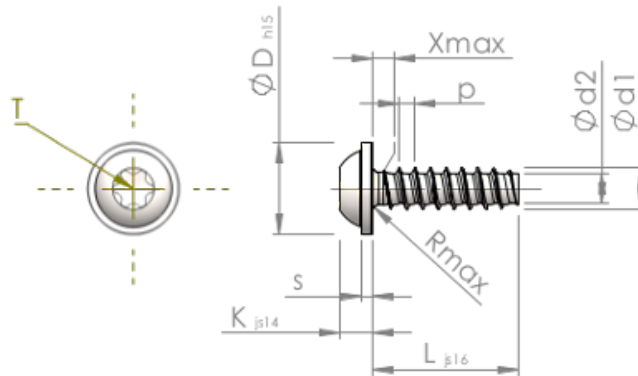

Item Number		STP380450180S
Standard		KN6038
Material		steel, hardened
Surface		zinc-plated 5-7 μ m, baked, blue / transparent passivated
Thread Outside- \varnothing	d1	4.50 $^{+0.10}$ mm
Thread Core- \varnothing	d2	3.17 mm
Thread Pitch	p	1.63 mm
Length	L	18.00 ± 0.55 mm
Head- \varnothing	D	10.00 $_{-0.58}$ mm
Head Height	K	3.200 ± 0.150 mm
Flange Thickness	S	1.10 mm
Thread Run-Out	X	2.30 mm
Radius	R	0.60 mm
Size Six Lobe		T20
Penetration Depth	t	1.40 - 1.80 mm
Thread		STS-plus
Weight		2.396 kg / 1000 pieces
Customs Tariff No		73 181 499