

**Technische gegevens**  
**STP380450150S**

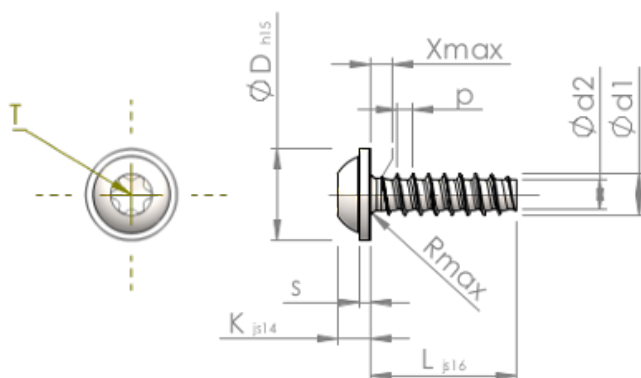

Produktnummer		STP380450150S
Norm		KN6038
Materiaal		veredeld staal
Oppervlak		verzinkt 5-7 $\mu\text{m}$ , getempert, blauw / transparant gepassiveerd
Schroefdraad buiten- $\varnothing$	<b>d1</b>	4.50 $^{+0.10}$ mm
Schroefdraad kern- $\varnothing$	<b>d2</b>	3.17 mm
Spoed	<b>p</b>	1.63 mm
Lengte	<b>L</b>	15.00 $\pm 0.55$ mm
Kop- $\varnothing$	<b>D</b>	10.00 $_{-0.58}$ mm
Kop hoogte	<b>K</b>	3.200 $\pm 0.150$ mm
Flensdikte	<b>S</b>	1.10 mm
Draaduitloop	<b>X</b>	2.30 mm
Radius	<b>R</b>	0.60 mm
TX		T20
Indringdiepte	<b>t</b>	1.40 - 1.80 mm
Draad		STS-plus
Gewicht		2.166 kg / 1000 stuk
Douane tarief nummer		73 181 499