

**Technische gegevens**  
**STP380400320B**

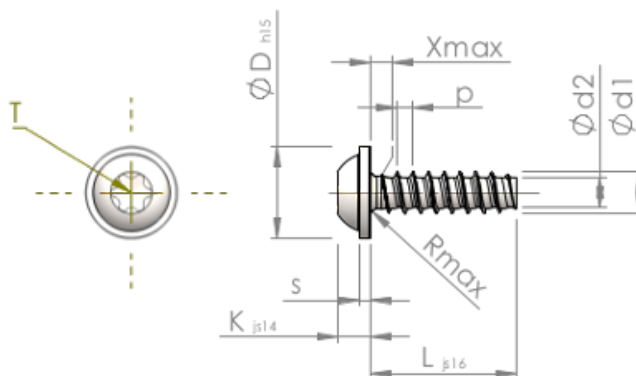

Produktnummer		STP380400320B
Norm		KN6038
Materiaal		veredeld staal
Oppervlak		ZnNi zwart-gepassiveerd, getempert, verzegeld
Schroefdraad buiten-Ø	<b>d1</b>	4.00 <sup>+0.10</sup> mm
Schroefdraad kern-Ø	<b>d2</b>	2.81 mm
Spoed	<b>p</b>	1.46 mm
Lengte	<b>L</b>	32.00 ±0.80 mm
Kop-Ø	<b>D</b>	9.00 <sub>-0.58</sub> mm
Kop hoogte	<b>K</b>	3.100 ±0.150 mm
Flensdikte	<b>S</b>	1.00 mm
Draaduitloop	<b>X</b>	2.00 mm
Radius	<b>R</b>	0.60 mm
TX		T20
Indringdiepte	<b>t</b>	1.40 - 1.80 mm
Draad		STS-plus
Gewicht		2.764 kg / 1000 stuk
Douane tarief nummer		73 181 499