

Spec Sheet STP380400160S

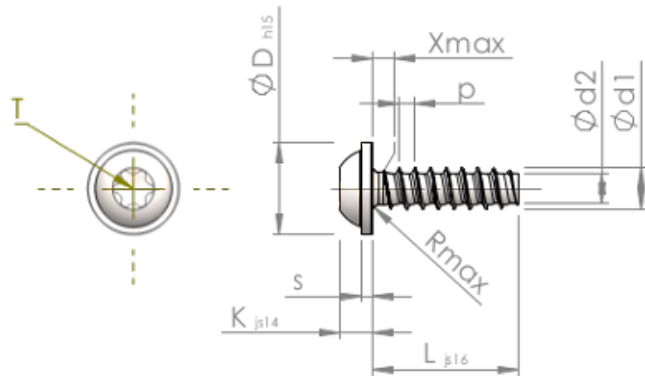

Item Number		STP380400160S
Standard		KN6038
Material		steel, hardened
Surface		zinc-plated 5-7 μm , baked, blue / transparent passivated
Thread Outside- Ø	d1	4.00 $^{+0.10}$ mm
Thread Core- Ø	d2	2.81 mm
Thread Pitch	p	1.46 mm
Length	L	16.00 ± 0.55 mm
Head- Ø	D	9.00 $_{-0.58}$ mm
Head Height	K	3.100 ± 0.150 mm
Flange Thickness	S	1.00 mm
Thread Run-Out	X	2.00 mm
Radius	R	0.60 mm
Size Six Lobe		T20
Penetration Depth	t	1.40 - 1.80 mm
Thread		STS-plus
Weight		1.794 kg / 1000 pieces
Customs Tariff No		73 181 499