

Spec Sheet STP380400160B

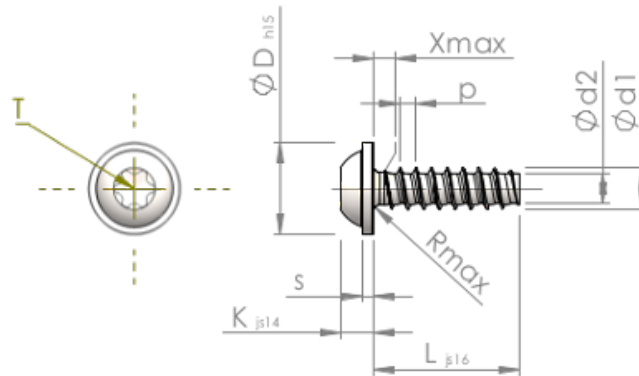

Item Number		STP380400160B
Standard		KN6038
Material		steel, hardened
Surface		Zinc-Nickel-plated min. 5µm, passivated black/ Cr-VI-free, baked, sealed
Thread Outside-Ø	d1	4.00 ^{+0.10} mm
Thread Core-Ø	d2	2.81 mm
Thread Pitch	p	1.46 mm
Length	L	16.00 ±0.55 mm
Head-Ø	D	9.00 _{-0.58} mm
Head Height	K	3.100 ±0.150 mm
Flange Thickness	S	1.00 mm
Thread Run-Out	X	2.00 mm
Radius	R	0.60 mm
Size Six Lobe		T20
Penetration Depth	t	1.40 - 1.80 mm
Thread		STS-plus
Weight		1.794 kg / 1000 pieces
Customs Tariff No		73 181 499