

Technische gegevens
STP380400070B

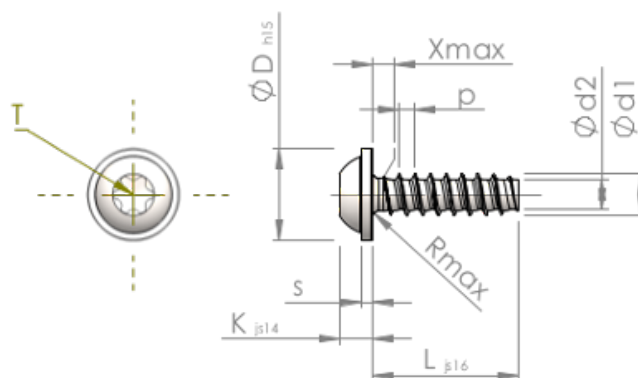

Produktnummer		STP380400070B
Norm		KN6038
Materiaal		veredeld staal
Oppervlak		ZnNi zwart-gepassiveerd, getempert, verzegeld
Schroefdraad buiten-Ø	d1	4.00 ^{+0.10} mm
Schroefdraad kern-Ø	d2	2.81 mm
Spoed	p	1.46 mm
Lengte	L	7.00 ±0.45 mm
Kop-Ø	D	9.00 _{-0.58} mm
Kop hoogte	K	3.100 ±0.150 mm
Flensdikte	S	1.00 mm
Draaduitloop	X	2.00 mm
Radius	R	0.60 mm
TX		T20
Indringdiepte	t	1.40 - 1.80 mm
Draad		STS-plus
Gewicht		1.248 kg / 1000 stuk
Douane tarief nummer		73 181 499