

Spec Sheet STP380350380E

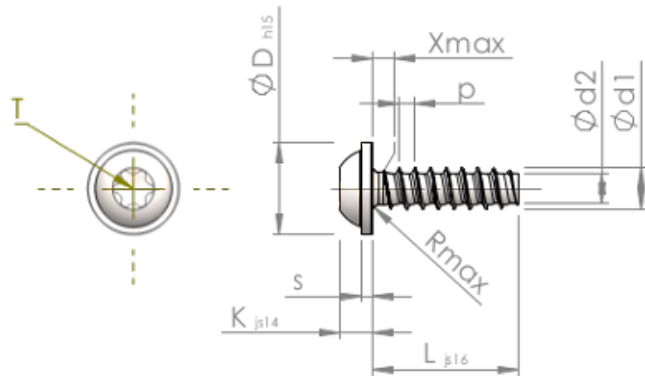

Item Number		STP380350380E
Standard		KN6038
Material		stainless-steel A2
Surface		bright, pickled and passivated
Thread Outside-Ø	d1	3.50 ^{+0.10} mm
Thread Core-Ø	d2	2.45 mm
Thread Pitch	p	1.29 mm
Length	L	38.00 ±0.80 mm
Head-Ø	D	7.50 _{-0.58} mm
Head Height	K	2.700 ±0.125 mm
Flange Thickness	S	0.90 mm
Thread Run-Out	X	1.80 mm
Radius	R	0.50 mm
Size Six Lobe		T15
Penetration Depth	t	1.10 - 1.50 mm
Thread		STS-plus
Weight		2.278 kg / 1000 pieces
Customs Tariff No		73 181 410