

Spec Sheet STP380350200J

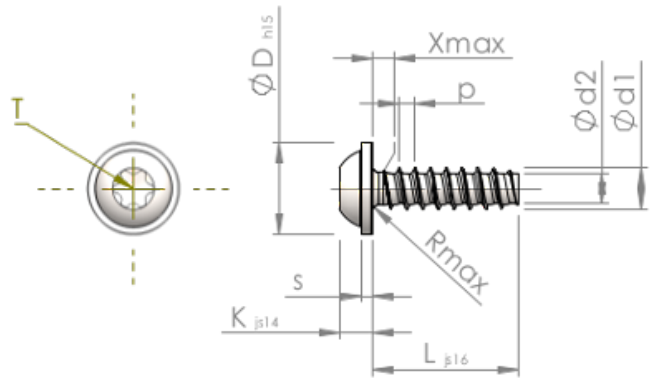

| | | |
|-------------------|-----------|--------------------------|
| Item Number | | STP380350200J |
| Standard | | KN6038 |
| Material | | stainless-steel A2 |
| Surface | | black |
| Thread Outside-Ø | d1 | 3.50 ^{+0.10} mm |
| Thread Core-Ø | d2 | 2.45 mm |
| Thread Pitch | p | 1.29 mm |
| Length | L | 20.00 ±0.65 mm |
| Head-Ø | D | 7.50 _{-0.58} mm |
| Head Height | K | 2.700 ±0.125 mm |
| Flange Thickness | S | 0.90 mm |
| Thread Run-Out | X | 1.80 mm |
| Radius | R | 0.50 mm |
| Size Six Lobe | | T15 |
| Penetration Depth | t | 1.10 - 1.50 mm |
| Thread | | STS-plus |
| Weight | | 1.427 kg / 1000 pieces |
| Customs Tariff No | | 73 181 410 |