

Spec Sheet STP380350160S

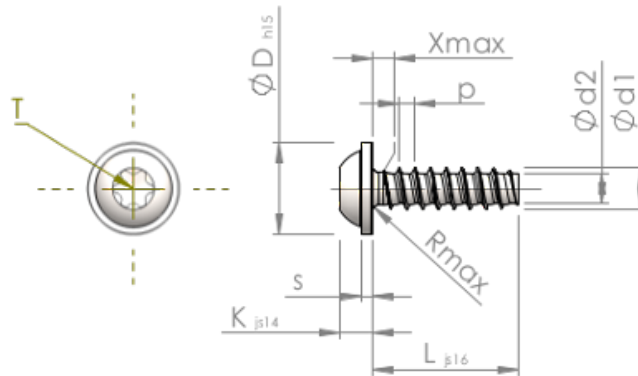

Item Number		STP380350160S
Standard		KN6038
Material		steel, hardened
Surface		zinc-plated 5-7 μ m, baked, blue / transparent passivated
Thread Outside- \varnothing	d1	3.50 $^{+0.10}$ mm
Thread Core- \varnothing	d2	2.45 mm
Thread Pitch	p	1.29 mm
Length	L	16.00 ± 0.55 mm
Head- \varnothing	D	7.50 $_{-0.58}$ mm
Head Height	K	2.700 ± 0.125 mm
Flange Thickness	S	0.90 mm
Thread Run-Out	X	1.80 mm
Radius	R	0.50 mm
Size Six Lobe		T15
Penetration Depth	t	1.10 - 1.50 mm
Thread		STS-plus
Weight		1.238 kg / 1000 pieces
Customs Tariff No		73 181 499