

Technische gegevens
STP380350130B

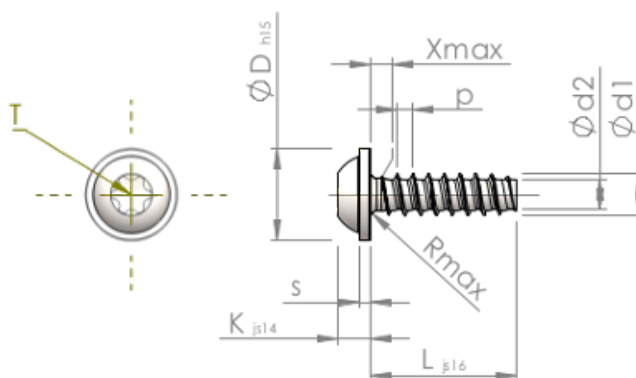

Produktnummer		STP380350130B
Norm		KN6038
Materiaal		veredeld staal
Oppervlak		ZnNi zwart-gepassiveerd, getempert, verzegeld
Schroefdraad buiten-Ø	d1	3.50 ^{+0.10} mm
Schroefdraad kern-Ø	d2	2.45 mm
Spoed	p	1.29 mm
Lengte	L	13.00 ±0.55 mm
Kop-Ø	D	7.50 _{-0.58} mm
Kop hoogte	K	2.700 ±0.125 mm
Flensdikte	S	0.90 mm
Draaduitloop	X	1.80 mm
Radius	R	0.50 mm
TX		T15
Indringdiepte	t	1.10 - 1.50 mm
Draad		STS-plus
Gewicht		1.097 kg / 1000 stuk
Douane tarief nummer		73 181 499