

**Technische gegevens**  
**STP380300280S**

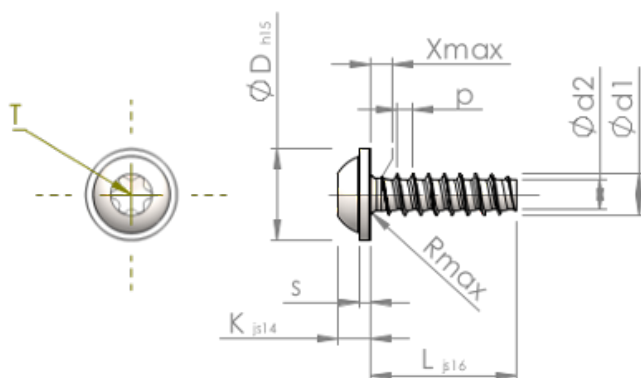

Produktnummer		STP380300280S
Norm		KN6038
Materiaal		veredeld staal
Oppervlak		verzinkt 5-7 $\mu\text{m}$ , getempert, blauw / transparant gepassiveerd
Schroefdraad buiten- $\varnothing$	<b>d1</b>	3.00 $^{+0.10}$ mm
Schroefdraad kern- $\varnothing$	<b>d2</b>	2.09 mm
Spoed	<b>p</b>	1.12 mm
Lengte	<b>L</b>	28.00 $\pm 0.65$ mm
Kop- $\varnothing$	<b>D</b>	6.50 $_{-0.58}$ mm
Kop hoogte	<b>K</b>	2.300 $\pm 0.125$ mm
Flensdikte	<b>S</b>	0.80 mm
Draaduitloop	<b>X</b>	1.50 mm
Radius	<b>R</b>	0.50 mm
TX		T10
Indringdiepte	<b>t</b>	1.00 - 1.30 mm
Draad		STS-plus
Gewicht		1.270 kg / 1000 stuk
Douane tarief nummer		73 181 499