

Spec Sheet STP380300280B

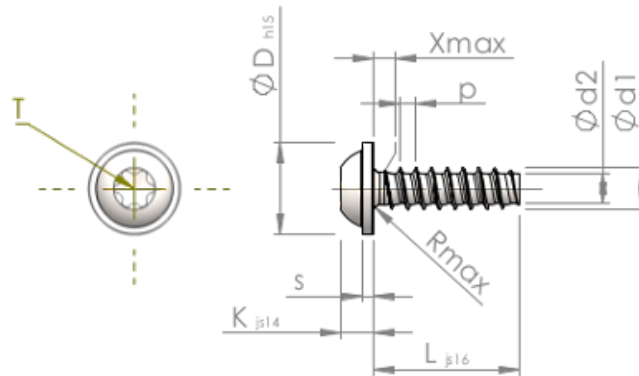

| | | |
|-------------------|-----------|--|
| Item Number | | STP380300280B |
| Standard | | KN6038 |
| Material | | steel, hardened |
| Surface | | Zinc-Nickel-plated min. 5µm, passivated black/ Cr-VI-free, baked, sealed |
| Thread Outside-Ø | d1 | 3.00 ^{+0.10} mm |
| Thread Core-Ø | d2 | 2.09 mm |
| Thread Pitch | p | 1.12 mm |
| Length | L | 28.00 ±0.65 mm |
| Head-Ø | D | 6.50 _{-0.58} mm |
| Head Height | K | 2.300 ±0.125 mm |
| Flange Thickness | S | 0.80 mm |
| Thread Run-Out | X | 1.50 mm |
| Radius | R | 0.50 mm |
| Size Six Lobe | | T10 |
| Penetration Depth | t | 1.00 - 1.30 mm |
| Thread | | STS-plus |
| Weight | | 1.270 kg / 1000 pieces |
| Customs Tariff No | | 73 181 499 |