

Technische gegevens
STP380300140E

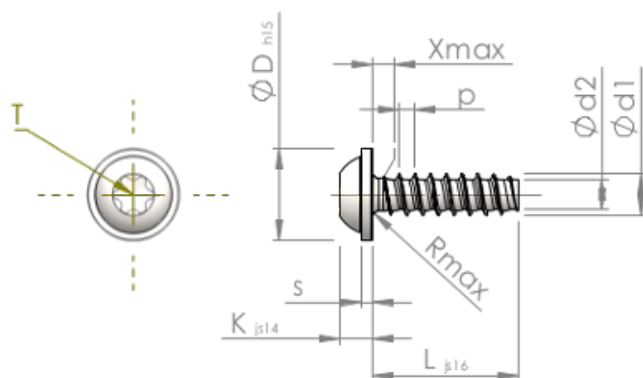

Produktnummer		STP380300140E
Norm		KN6038
Materiaal		roestvrij staal A2
Oppervlak		blank, geetst en gepassiveerd
Schroefdraad buiten-Ø	d1	3.00 ^{+0.10} mm
Schroefdraad kern-Ø	d2	2.09 mm
Spoed	p	1.12 mm
Lengte	L	14.00 ±0.55 mm
Kop-Ø	D	6.50 _{-0.58} mm
Kop hoogte	K	2.300 ±0.125 mm
Flensdikte	S	0.80 mm
Draaduitloop	X	1.50 mm
Radius	R	0.50 mm
TX		T10
Indringdiepte	t	1.00 - 1.30 mm
Draad		STS-plus
Gewicht		0.795 kg / 1000 stuk
Douane tarief nummer		73 181 410