

Technische gegevens
STP380300110S

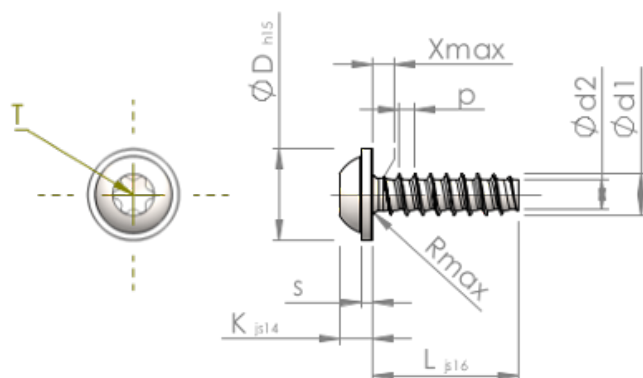

Produktnummer		STP380300110S
Norm		KN6038
Materiaal		veredeld staal
Oppervlak		verzinkt 5-7 μ m, getempert, blauw / transparant gepassiveerd
Schroefdraad buiten- \varnothing	d1	3.00 $^{+0.10}$ mm
Schroefdraad kern- \varnothing	d2	2.09 mm
Spoed	p	1.12 mm
Lengte	L	11.00 ± 0.55 mm
Kop- \varnothing	D	6.50 $_{-0.58}$ mm
Kop hoogte	K	2.300 ± 0.125 mm
Flensdikte	S	0.80 mm
Draaduitloop	X	1.50 mm
Radius	R	0.50 mm
TX		T10
Indringdiepte	t	1.00 - 1.30 mm
Draad		STS-plus
Gewicht		0.693 kg / 1000 stuk
Douane tarief nummer		73 181 499