

Spec Sheet STP380300060S

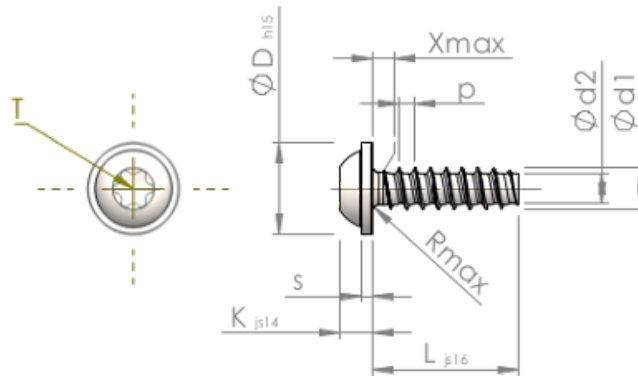

Item Number		STP380300060S
Standard		KN6038
Material		steel, hardened
Surface		zinc-plated 5-7 µm, baked, blue / transparent passivated
Thread Outside-Ø	d1	3.00 ^{+0.10} mm
Thread Core-Ø	d2	2.09 mm
Thread Pitch	p	1.12 mm
Length	L	6.00 ±0.38 mm
Head-Ø	D	6.50 _{-0.58} mm
Head Height	K	2.300 ±0.125 mm
Flange Thickness	S	0.80 mm
Thread Run-Out	X	1.50 mm
Radius	R	0.50 mm
Size Six Lobe		T10
Penetration Depth	t	1.00 - 1.30 mm
Thread		STS-plus
Weight		0.523 kg / 1000 pieces
Customs Tariff No		73 181 499