

Spec Sheet STP380300050E

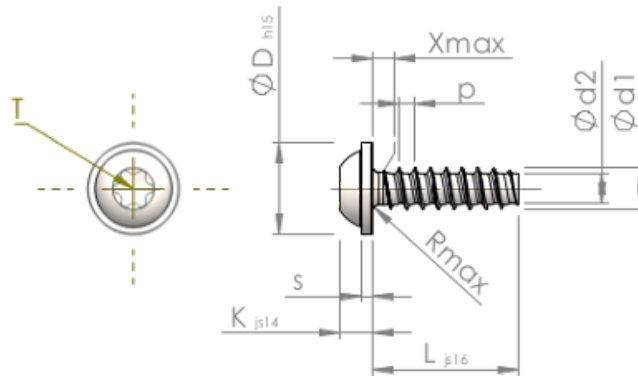

Item Number		STP380300050E
Standard		KN6038
Material		stainless-steel A2
Surface		bright, pickled and passivated
Thread Outside-Ø	<b>d1</b>	3.00 <sup>+0.10</sup> mm
Thread Core-Ø	<b>d2</b>	2.09 mm
Thread Pitch	<b>p</b>	1.12 mm
Length	<b>L</b>	5.00 ±0.38 mm
Head-Ø	<b>D</b>	6.50 <sub>-0.58</sub> mm
Head Height	<b>K</b>	2.300 ±0.125 mm
Flange Thickness	<b>S</b>	0.80 mm
Thread Run-Out	<b>X</b>	1.50 mm
Radius	<b>R</b>	0.50 mm
Size Six Lobe		T10
Penetration Depth	<b>t</b>	1.00 - 1.30 mm
Thread		STS-plus
Weight		0.489 kg / 1000 pieces
Customs Tariff No		73 181 410