

Spec Sheet STP380250220E

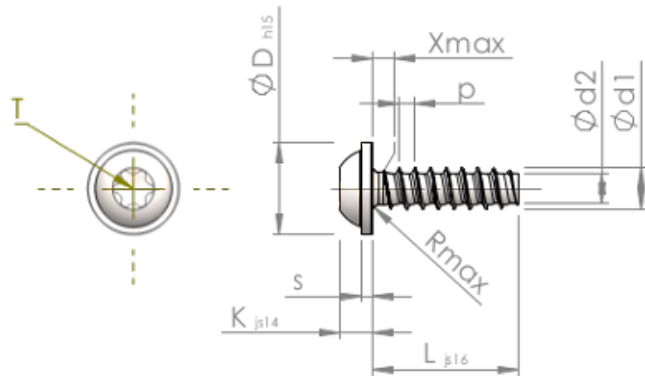

Item Number		STP380250220E
Standard		KN6038
Material		stainless-steel A2
Surface		bright, pickled and passivated
Thread Outside-Ø	d1	2.50 ^{+0.10} mm
Thread Core-Ø	d2	1.72 mm
Thread Pitch	p	0.95 mm
Length	L	22.00 ±0.65 mm
Head-Ø	D	5.50 _{-0.48} mm
Head Height	K	1.900 ±0.125 mm
Flange Thickness	S	0.70 mm
Thread Run-Out	X	1.30 mm
Radius	R	0.40 mm
Size Six Lobe		T8
Penetration Depth	t	0.80 - 1.00 mm
Thread		STS-plus
Weight		0.708 kg / 1000 pieces
Customs Tariff No		73 181 410