

**Technische gegevens**  
**STP380250140S**

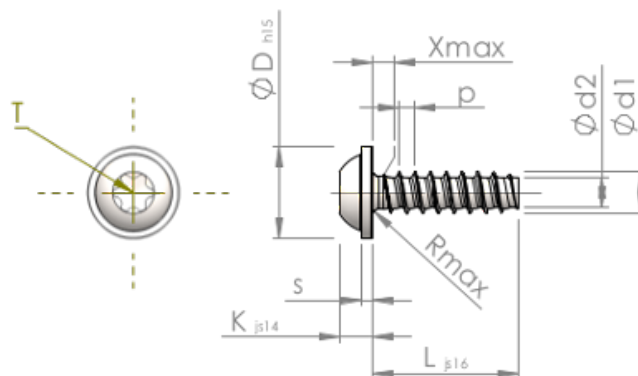

Produktnummer		STP380250140S
Norm		KN6038
Materiaal		veredeld staal
Oppervlak		verzinkt 5-7 µm, getempert, blauw / transparant gepassiveerd
Schroefdraad buiten-Ø	<b>d1</b>	2.50 <sup>+0.10</sup> mm
Schroefdraad kern-Ø	<b>d2</b>	1.72 mm
Spoed	<b>p</b>	0.95 mm
Lengte	<b>L</b>	14.00 ±0.55 mm
Kop-Ø	<b>D</b>	5.50 <sub>-0.48</sub> mm
Kop hoogte	<b>K</b>	1.900 ±0.125 mm
Flensdikte	<b>S</b>	0.70 mm
Draaduitloop	<b>X</b>	1.30 mm
Radius	<b>R</b>	0.40 mm
TX		T8
Indringdiepte	<b>t</b>	0.80 - 1.00 mm
Draad		STS-plus
Gewicht		0.516 kg / 1000 stuk
Douane tarief nummer		73 181 499