

Spec Sheet STP380250120S

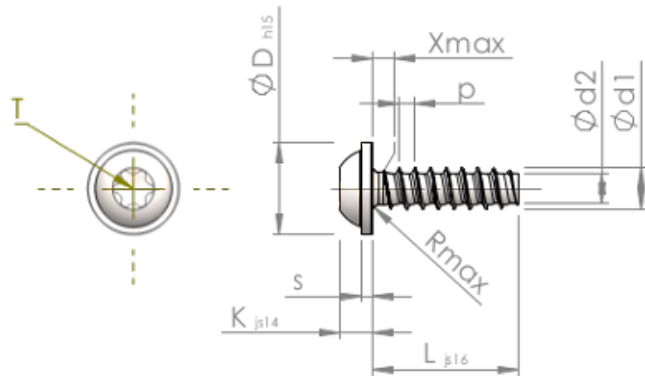

Item Number		STP380250120S
Standard		KN6038
Material		steel, hardened
Surface		zinc-plated 5-7 μ m, baked, blue / transparent passivated
Thread Outside- \varnothing	d1	2.50 $^{+0.10}$ mm
Thread Core- \varnothing	d2	1.72 mm
Thread Pitch	p	0.95 mm
Length	L	12.00 ± 0.55 mm
Head- \varnothing	D	5.50 $_{-0.48}$ mm
Head Height	K	1.900 ± 0.125 mm
Flange Thickness	S	0.70 mm
Thread Run-Out	X	1.30 mm
Radius	R	0.40 mm
Size Six Lobe		T8
Penetration Depth	t	0.80 - 1.00 mm
Thread		STS-plus
Weight		0.468 kg / 1000 pieces
Customs Tariff No		73 181 499