

Technische gegevens
STP380250110S

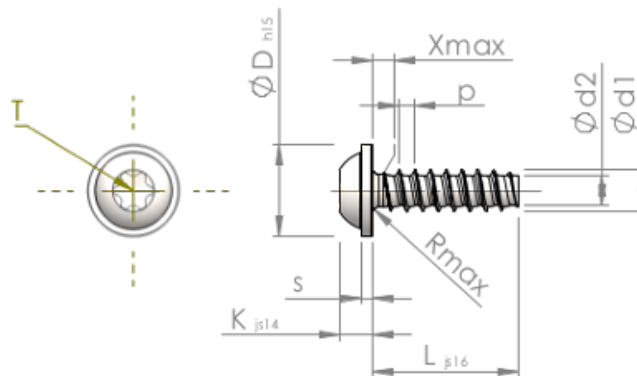

Produktnummer		STP380250110S
Norm		KN6038
Materiaal		veredeld staal
Oppervlak		verzinkt 5-7 μm , getempert, blauw / transparant gepassiveerd
Schroefdraad buiten- \varnothing	d1	2.50 $^{+0.10}$ mm
Schroefdraad kern- \varnothing	d2	1.72 mm
Spoed	p	0.95 mm
Lengte	L	11.00 ± 0.55 mm
Kop- \varnothing	D	5.50 $_{-0.48}$ mm
Kop hoogte	K	1.900 ± 0.125 mm
Flensdikte	S	0.70 mm
Draaduitloop	X	1.30 mm
Radius	R	0.40 mm
TX		T8
Indringdiepte	t	0.80 - 1.00 mm
Draad		STS-plus
Gewicht		0.443 kg / 1000 stuk
Douane tarief nummer		73 181 499