

Spec Sheet STP380250045B

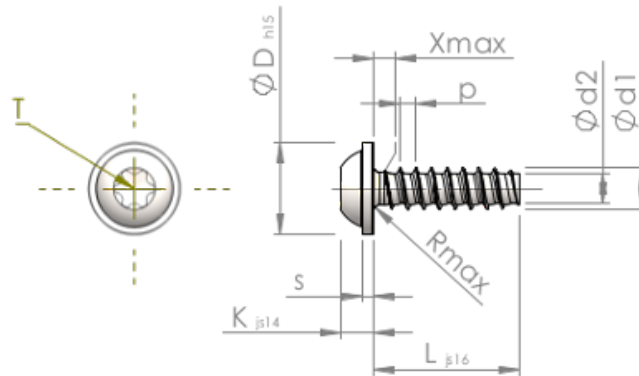

Item Number		STP380250045B
Standard		KN6038
Material		steel, hardened
Surface		Zinc-Nickel-plated min. 5µm, passivated black/ Cr-VI-free, baked, sealed
Thread Outside-Ø	<b>d1</b>	2.50 <sup>+0.10</sup> mm
Thread Core-Ø	<b>d2</b>	1.72 mm
Thread Pitch	<b>p</b>	0.95 mm
Length	<b>L</b>	4.50 ±0.38 mm
Head-Ø	<b>D</b>	5.50 <sub>-0.48</sub> mm
Head Height	<b>K</b>	1.900 ±0.125 mm
Flange Thickness	<b>S</b>	0.70 mm
Thread Run-Out	<b>X</b>	1.30 mm
Radius	<b>R</b>	0.40 mm
Size Six Lobe		T8
Penetration Depth	<b>t</b>	0.80 - 1.00 mm
Thread		STS-plus
Weight		0.287 kg / 1000 pieces
Customs Tariff No		73 181 499