

Spec Sheet STP380220220S

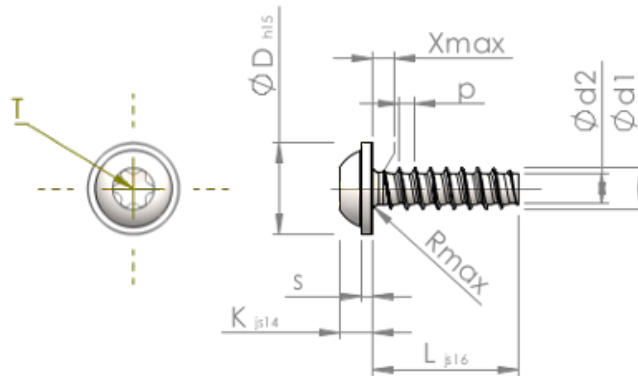

Item Number		STP380220220S
Standard		KN6038
Material		steel, hardened
Surface		zinc-plated 5-7 μ m, baked, blue / transparent passivated
Thread Outside- \varnothing	d1	2.20 $^{+0.08}$ mm
Thread Core- \varnothing	d2	1.51 mm
Thread Pitch	p	0.85 mm
Length	L	22.00 ± 0.65 mm
Head- \varnothing	D	5.00 $_{-0.48}$ mm
Head Height	K	1.600 ± 0.125 mm
Flange Thickness	S	0.60 mm
Thread Run-Out	X	1.10 mm
Radius	R	0.35 mm
Size Six Lobe		T6
Penetration Depth	t	0.65 - 0.85 mm
Thread		STS-plus
Weight		0.531 kg / 1000 pieces
Customs Tariff No		73 181 499