

Spec Sheet STP380220200B

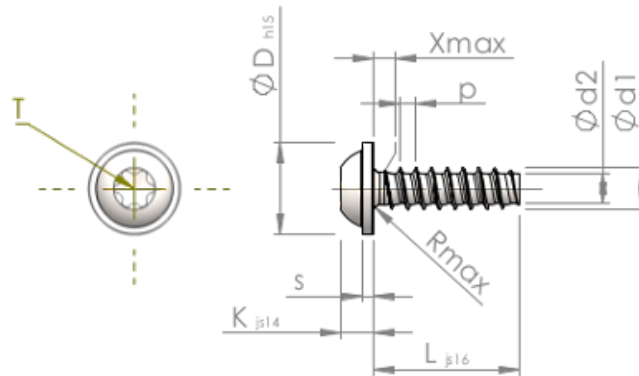

Item Number		STP380220200B
Standard		KN6038
Material		steel, hardened
Surface		Zinc-Nickel-plated min. 5µm, passivated black/ Cr-VI-free, baked, sealed
Thread Outside-Ø	d1	2.20 ^{+0.08} mm
Thread Core-Ø	d2	1.51 mm
Thread Pitch	p	0.85 mm
Length	L	20.00 ±0.65 mm
Head-Ø	D	5.00 _{-0.48} mm
Head Height	K	1.600 ±0.125 mm
Flange Thickness	S	0.60 mm
Thread Run-Out	X	1.10 mm
Radius	R	0.35 mm
Size Six Lobe		T6
Penetration Depth	t	0.65 - 0.85 mm
Thread		STS-plus
Weight		0.494 kg / 1000 pieces
Customs Tariff No		73 181 499