

Spec Sheet STP380220130B

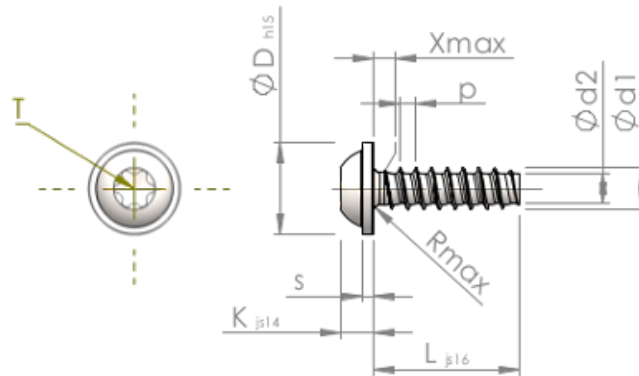

| | | |
|-------------------|-----------|--|
| Item Number | | STP380220130B |
| Standard | | KN6038 |
| Material | | steel, hardened |
| Surface | | Zinc-Nickel-plated min. 5µm, passivated black/ Cr-VI-free, baked, sealed |
| Thread Outside-Ø | d1 | 2.20 ^{+0.08} mm |
| Thread Core-Ø | d2 | 1.51 mm |
| Thread Pitch | p | 0.85 mm |
| Length | L | 13.00 ±0.55 mm |
| Head-Ø | D | 5.00 _{-0.48} mm |
| Head Height | K | 1.600 ±0.125 mm |
| Flange Thickness | S | 0.60 mm |
| Thread Run-Out | X | 1.10 mm |
| Radius | R | 0.35 mm |
| Size Six Lobe | | T6 |
| Penetration Depth | t | 0.65 - 0.85 mm |
| Thread | | STS-plus |
| Weight | | 0.364 kg / 1000 pieces |
| Customs Tariff No | | 73 181 499 |