

Spec Sheet STP380220080B

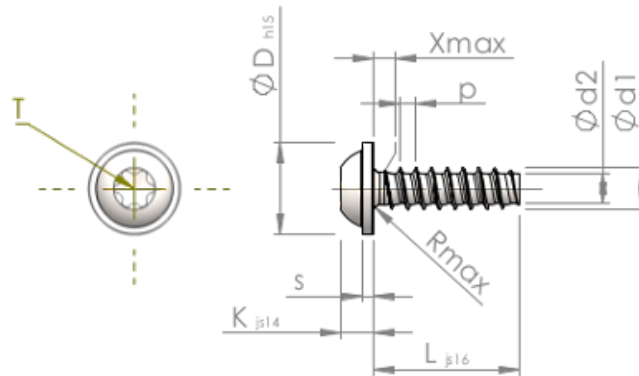

|                   |           |  |
|-------------------|-----------|--|
| Item Number       |           | STP380220080B  |
| Standard          |           | KN6038   |
| Material          |           | steel, hardened  |
| Surface           |           | Zinc-Nickel-plated min. 5µm, passivated black/ Cr-VI-free, baked, sealed |
| Thread Outside-Ø  | <b>d1</b> | 2.20 <sup>+0.08</sup> mm   |
| Thread Core-Ø     | <b>d2</b> | 1.51 mm  |
| Thread Pitch      | <b>p</b>  | 0.85 mm  |
| Length            | <b>L</b>  | 8.00 ±0.45 mm  |
| Head-Ø            | <b>D</b>  | 5.00 <sub>-0.48</sub> mm   |
| Head Height       | <b>K</b>  | 1.600 ±0.125 mm  |
| Flange Thickness  | <b>S</b>  | 0.60 mm  |
| Thread Run-Out    | <b>X</b>  | 1.10 mm  |
| Radius            | <b>R</b>  | 0.35 mm  |
| Size Six Lobe     |           | T6   |
| Penetration Depth | <b>t</b>  | 0.65 - 0.85 mm   |
| Thread            |           | STS-plus   |
| Weight            |           | 0.272 kg / 1000 pieces   |
| Customs Tariff No |           | 73 181 499   |