

Technische gegevens
STP380220070B

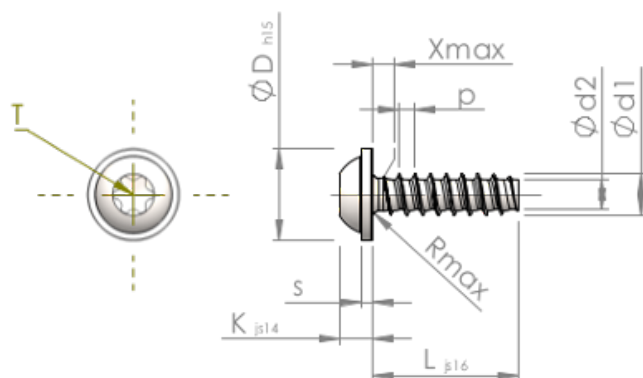

Produktnummer		STP380220070B
Norm		KN6038
Materiaal		veredeld staal
Oppervlak		ZnNi zwart-gepassiveerd, getempert, verzegeld
Schroefdraad buiten- \varnothing	d1	2.20 ^{+0.08} mm
Schroefdraad kern- \varnothing	d2	1.51 mm
Spoed	p	0.85 mm
Lengte	L	7.00 ± 0.45 mm
Kop- \varnothing	D	5.00 _{-0.48} mm
Kop hoogte	K	1.600 ± 0.125 mm
Flensdikte	S	0.60 mm
Draaduitloop	X	1.10 mm
Radius	R	0.35 mm
TX		T6
Indringdiepte	t	0.65 - 0.85 mm
Draad		STS-plus
Gewicht		0.253 kg / 1000 stuk
Douane tarief nummer		73 181 499