

Technische gegevens
STP380200150S

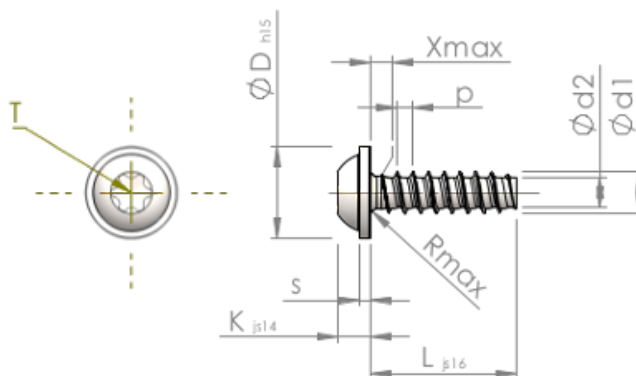

Produktnummer		STP380200150S
Norm		KN6038
Materiaal		veredeld staal
Oppervlak		verzinkt 5-7 µm, getempert, blauw / transparant gepassiveerd
Schroefdraad buiten-Ø	d1	2.00 ^{+0.08} mm
Schroefdraad kern-Ø	d2	1.36 mm
Spoed	p	0.78 mm
Lengte	L	15.00 ±0.55 mm
Kop-Ø	D	4.50 _{-0.48} mm
Kop hoogte	K	1.600 ±0.125 mm
Flensdikte	S	0.60 mm
Draaduitloop	X	1.00 mm
Radius	R	0.35 mm
TX		T6
Indringdiepte	t	0.65 - 0.85 mm
Draad		STS-plus
Gewicht		0.336 kg / 1000 stuk
Douane tarief nummer		73 181 499