

Spec Sheet STP380180160S

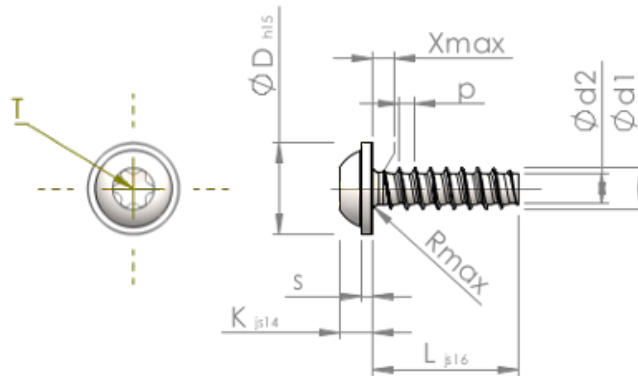

Item Number		STP380180160S
Standard		KN6038
Material		steel, hardened
Surface		zinc-plated 5-7 μm , baked, blue / transparent passivated
Thread Outside- Ø	d1	1.80 $^{+0.08}$ mm
Thread Core- Ø	d2	1.22 mm
Thread Pitch	p	0.71 mm
Length	L	16.00 ± 0.55 mm
Head- Ø	D	4.00 $_{-0.48}$ mm
Head Height	K	1.350 ± 0.125 mm
Flange Thickness	S	0.60 mm
Thread Run-Out	X	0.90 mm
Radius	R	0.25 mm
Size Six Lobe		T6
Penetration Depth	t	0.50 - 0.65 mm
Thread		STS-plus
Weight		0.272 kg / 1000 pieces
Customs Tariff No		73 181 499