

Spec Sheet STP380160120B

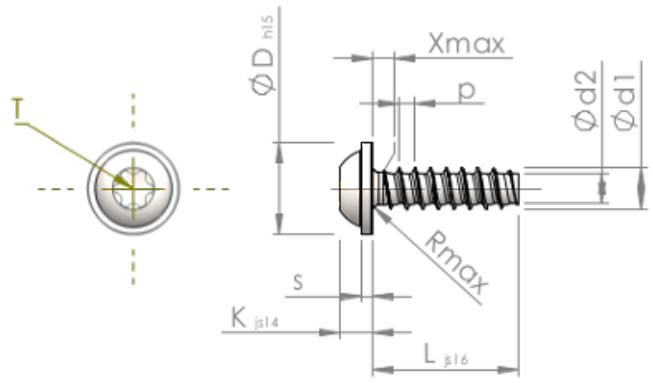

Item Number		STP380160120B
Standard		KN6038
Material		steel, hardened
Surface		Zinc-Nickel-plated min. 5µm, passivated black/ Cr-VI-free, baked, sealed
Thread Outside-Ø	<b>d1</b>	1.60 <sup>+0.08</sup> mm
Thread Core-Ø	<b>d2</b>	1.07 mm
Thread Pitch	<b>p</b>	0.64 mm
Length	<b>L</b>	12.00 ±0.55 mm
Head-Ø	<b>D</b>	3.60 <sub>-0.48</sub> mm
Head Height	<b>K</b>	1.200 ±0.125 mm
Flange Thickness	<b>S</b>	0.60 mm
Thread Run-Out	<b>X</b>	0.80 mm
Radius	<b>R</b>	0.25 mm
Size Six Lobe		T5
Penetration Depth	<b>t</b>	0.50 - 0.65 mm
Thread		STS-plus
Weight		0.172 kg / 1000 pieces
Customs Tariff No		73 181 499