

Spec Sheet STP380160110S

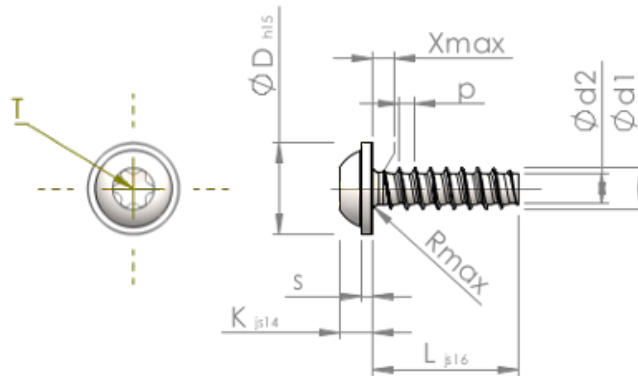

Item Number		STP380160110S
Standard		KN6038
Material		steel, hardened
Surface		zinc-plated 5-7 µm, baked, blue / transparent passivated
Thread Outside-Ø	d1	1.60 ^{+0.08} mm
Thread Core-Ø	d2	1.07 mm
Thread Pitch	p	0.64 mm
Length	L	11.00 ±0.55 mm
Head-Ø	D	3.60 _{-0.48} mm
Head Height	K	1.200 ±0.125 mm
Flange Thickness	S	0.60 mm
Thread Run-Out	X	0.80 mm
Radius	R	0.25 mm
Size Six Lobe		T5
Penetration Depth	t	0.50 - 0.65 mm
Thread		STS-plus
Weight		0.163 kg / 1000 pieces
Customs Tariff No		73 181 499