

# Spec Sheet STP380160100S

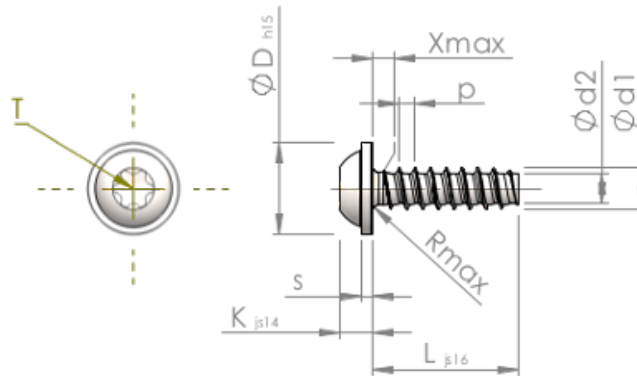

Item Number		STP380160100S
Standard		KN6038
Material		steel, hardened
Surface		zinc-plated 5-7 $\mu$ m, baked, blue / transparent passivated
Thread Outside- $\varnothing$	<b>d1</b>	1.60 $^{+0.08}$ mm
Thread Core- $\varnothing$	<b>d2</b>	1.07 mm
Thread Pitch	<b>p</b>	0.64 mm
Length	<b>L</b>	10.00 $\pm 0.45$ mm
Head- $\varnothing$	<b>D</b>	3.60 $_{-0.48}$ mm
Head Height	<b>K</b>	1.200 $\pm 0.125$ mm
Flange Thickness	<b>S</b>	0.60 mm
Thread Run-Out	<b>X</b>	0.80 mm
Radius	<b>R</b>	0.25 mm
Size Six Lobe		T5
Penetration Depth	<b>t</b>	0.50 - 0.65 mm
Thread		STS-plus
Weight		0.153 kg / 1000 pieces
Customs Tariff No		73 181 499