

Technische gegevens
STP380160070E

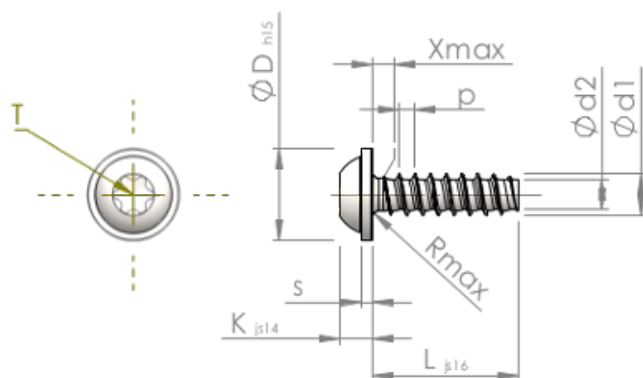

Produktnummer		STP380160070E
Norm		KN6038
Materiaal		roestvrij staal A2
Oppervlak		blank, geetst en gepassiveerd
Schroefdraad buiten- \varnothing	d1	1.60 ^{+0.08} mm
Schroefdraad kern- \varnothing	d2	1.07 mm
Spoed	p	0.64 mm
Lengte	L	7.00 ± 0.45 mm
Kop- \varnothing	D	3.60 _{-0.48} mm
Kop hoogte	K	1.200 ± 0.125 mm
Flensdikte	S	0.60 mm
Draaduitloop	X	0.80 mm
Radius	R	0.25 mm
TX		T5
Indringdiepte	t	0.50 - 0.65 mm
Draad		STS-plus
Gewicht		0.123 kg / 1000 stuk
Douane tarief nummer		73 181 410