

Spec Sheet STP380140140S

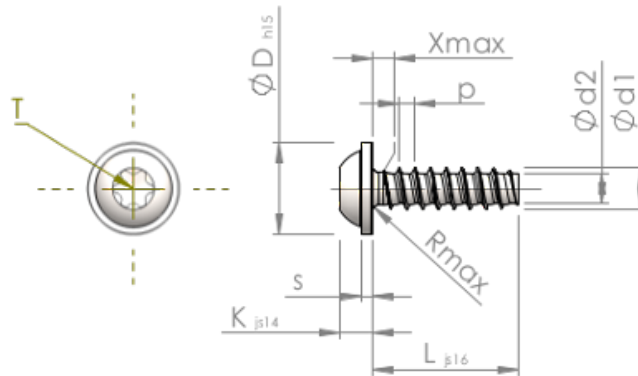

Item Number		STP380140140S
Standard		KN6038
Material		steel, hardened
Surface		zinc-plated 5-7 μ m, baked, blue / transparent passivated
Thread Outside- \varnothing	d1	1.40 $^{+0.08}$ mm
Thread Core- \varnothing	d2	0.93 mm
Thread Pitch	p	0.57 mm
Length	L	14.00 ± 0.55 mm
Head- \varnothing	D	3.20 $_{-0.48}$ mm
Head Height	K	1.150 ± 0.125 mm
Flange Thickness	S	0.50 mm
Thread Run-Out	X	0.70 mm
Radius	R	0.20 mm
Size Six Lobe		T5
Penetration Depth	t	0.40 - 0.55 mm
Thread		STS-plus
Weight		0.145 kg / 1000 pieces
Customs Tariff No		73 181 499