

Spec Sheet STP380140090B

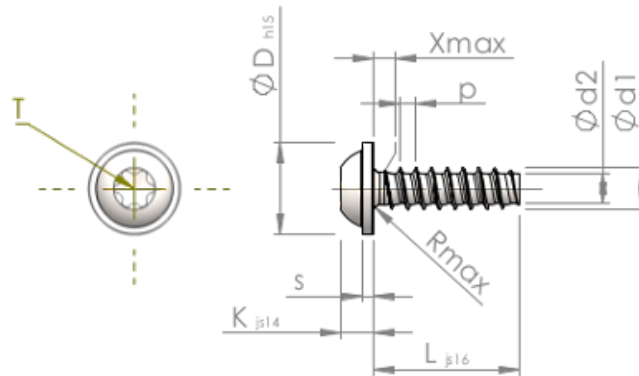

Item Number		STP380140090B
Standard		KN6038
Material		steel, hardened
Surface		Zinc-Nickel-plated min. 5µm, passivated black/ Cr-VI-free, baked, sealed
Thread Outside-Ø	d1	1.40 ^{+0.08} mm
Thread Core-Ø	d2	0.93 mm
Thread Pitch	p	0.57 mm
Length	L	9.00 ±0.45 mm
Head-Ø	D	3.20 _{-0.48} mm
Head Height	K	1.150 ±0.125 mm
Flange Thickness	S	0.50 mm
Thread Run-Out	X	0.70 mm
Radius	R	0.20 mm
Size Six Lobe		T5
Penetration Depth	t	0.40 - 0.55 mm
Thread		STS-plus
Weight		0.107 kg / 1000 pieces
Customs Tariff No		73 181 499