

Spec Sheet STP380140035B

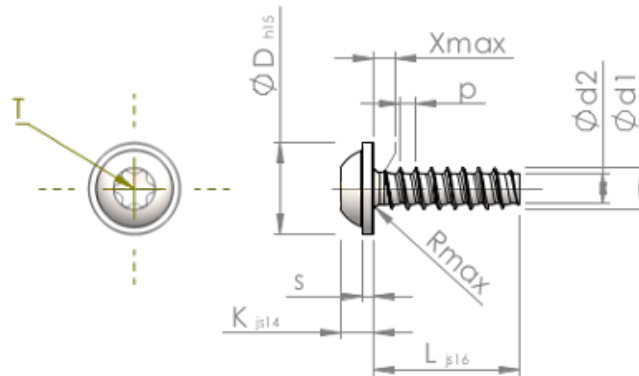

| | | |
|-------------------|-----------|--|
| Item Number | | STP380140035B |
| Standard | | KN6038 |
| Material | | steel, hardened |
| Surface | | Zinc-Nickel-plated min. 5µm, passivated black/ Cr-VI-free, baked, sealed |
| Thread Outside-Ø | d1 | 1.40 ^{+0.08} mm |
| Thread Core-Ø | d2 | 0.93 mm |
| Thread Pitch | p | 0.57 mm |
| Length | L | 3.50 ±0.38 mm |
| Head-Ø | D | 3.20 _{-0.48} mm |
| Head Height | K | 1.150 ±0.125 mm |
| Flange Thickness | S | 0.50 mm |
| Thread Run-Out | X | 0.70 mm |
| Radius | R | 0.20 mm |
| Size Six Lobe | | T5 |
| Penetration Depth | t | 0.40 - 0.55 mm |
| Thread | | STS-plus |
| Weight | | 0.065 kg / 1000 pieces |
| Customs Tariff No | | 73 181 499 |