

Detalii tehnice STP33A0600550S

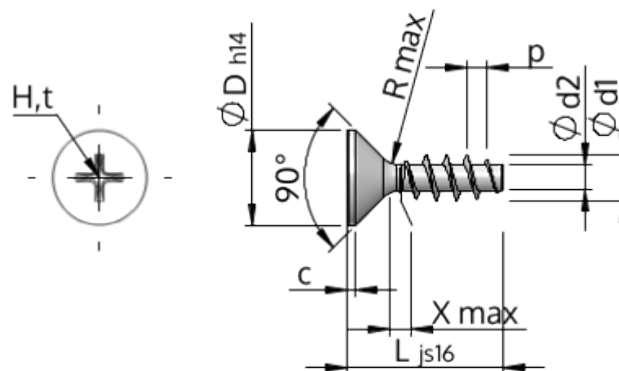

Numărul articolului		STP33A0600550S
Norma		KN1033
Material		oțel, călit
Exterior		zincat 5-7 μm , recopt, pasivat transparent/albastru
Diametrul exterior al filetului-Ø	d1	6.00 $^{+0.18}$ mm
Diametru șurub	d2	3.19 mm
Pasul filetului	p	2.69 mm
Lungimea	L	55.00 ± 0.95 mm
Diametrul capului-Ø	D	11.30 $_{-0.43}$ mm
Cap cilindric	C	0.85 mm
Tija	X	3.00 mm
Radius	R	0.60 mm
Dimensiune Locaș Cruciform		H2
Adâncimea de penetrării	t	2.59 - 3.22 mm
Fir		STS
Greutate		6.748 kg / 1000 unități
Tariful vamal nr.		73 181 499