

Spec Sheet STP33A0600180E

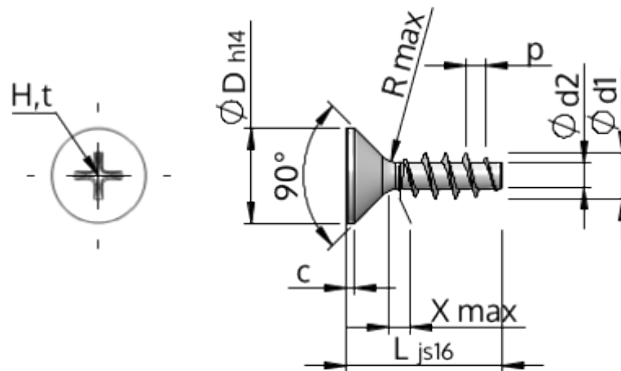

Item Number		STP33A0600180E
Standard		KN1033
Material		stainless-steel A2
Surface		bright, pickled and passivated
Thread Outside-Ø	d1	6.00 ^{+0.18} mm
Thread Core-Ø	d2	3.19 mm
Thread Pitch	p	2.69 mm
Length	L	18.00 ±0.55 mm
Head-Ø	D	11.30 _{-0.43} mm
Cylindrical Head Height	C	0.85 mm
Thread Run-Out	X	3.00 mm
Radius	R	0.60 mm
Size Cross Recess		H2
Penetration Depth	t	2.59 - 3.22 mm
Thread		STS
Weight		2.970 kg / 1000 pieces
Customs Tariff No		73 181 410