

Technische gegevens
STP33A0600140S

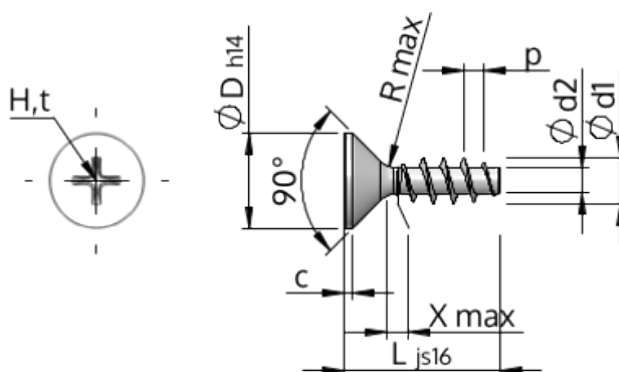

Produktnummer		STP33A0600140S
Norm		KN1033
Materiaal		veredeld staal
Oppervlak		verzinkt 5-7 µm, getempert, blauw / transparant gepassiveerd
Schroefdraad buiten-Ø	d1	6.00 ^{+0.18} mm
Schroefdraad kern-Ø	d2	3.19 mm
Spoed	p	2.69 mm
Lengte	L	14.00 ±0.55 mm
Kop-Ø	D	11.30 _{-0.43} mm
Cylindrische kophoogte	C	0.85 mm
Draaduitloop	X	3.00 mm
Radius	R	0.60 mm
Kruis Maat		H2
Indringdiepte	t	2.59 - 3.22 mm
Draad		STS
Gewicht		2.562 kg / 1000 stuk
Douane tarief nummer		73 181 499