

Spec Sheet STP33A0500500S

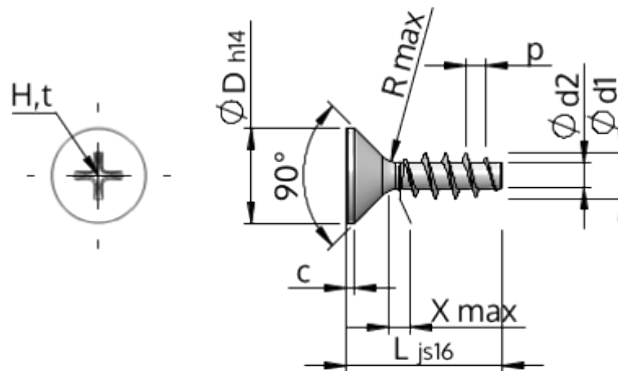

Item Number		STP33A0500500S
Standard		KN1033
Material		steel, hardened
Surface		zinc-plated 5-7 µm, baked, blue / transparent passivated
Thread Outside-Ø	<b>d1</b>	5.00 <sup>+0.18</sup> mm
Thread Core-Ø	<b>d2</b>	2.68 mm
Thread Pitch	<b>p</b>	2.24 mm
Length	<b>L</b>	50.00 ±0.80 mm
Head-Ø	<b>D</b>	9.30 <sub>-0.36</sub> mm
Cylindrical Head Height	<b>C</b>	0.75 mm
Thread Run-Out	<b>X</b>	2.50 mm
Radius	<b>R</b>	0.45 mm
Size Cross Recess		H2
Penetration Depth	<b>t</b>	2.04 - 2.67 mm
Thread		STS
Weight		4.226 kg / 1000 pieces
Customs Tariff No		73 181 499