

Detalii tehnice STP33A0500450S

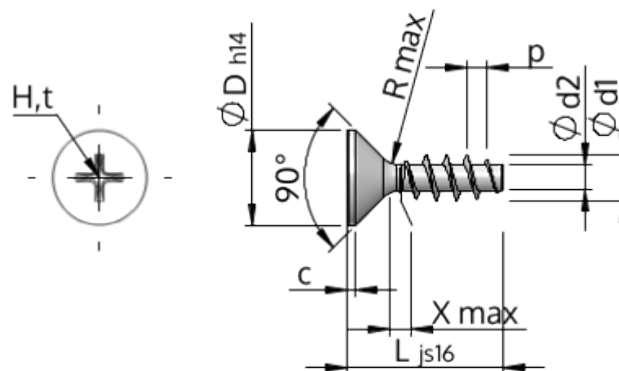

Numărul articolului		STP33A0500450S
Norma		KN1033
Material		oțel, călit
Exterior		zincat 5-7 μm , repect, pasivat transparent/albastru
Diametrul exterior al filetului-Ø	d1	5.00 $^{+0.18}$ mm
Diametru șurub	d2	2.68 mm
Pasul filetului	p	2.24 mm
Lungimea	L	45.00 ± 0.80 mm
Diametrul capului-Ø	D	9.30 $_{-0.36}$ mm
Cap cilindric	C	0.75 mm
Tija	X	2.50 mm
Radius	R	0.45 mm
Dimensiune Locaș Cruciform		H2
Adâncimea de penetrării	t	2.04 - 2.67 mm
Fir		STS
Greutate		3.856 kg / 1000 unități
Tariful vamal nr.		73 181 499