

Spec Sheet STP33A0500200E

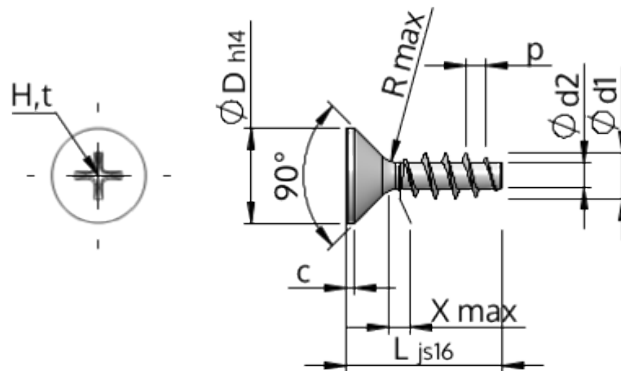

Item Number		STP33A0500200E
Standard		KN1033
Material		stainless-steel A2
Surface		bright, pickled and passivated
Thread Outside-Ø	d1	5.00 ^{+0.18} mm
Thread Core-Ø	d2	2.68 mm
Thread Pitch	p	2.24 mm
Length	L	20.00 ±0.65 mm
Head-Ø	D	9.30 _{-0.36} mm
Cylindrical Head Height	C	0.75 mm
Thread Run-Out	X	2.50 mm
Radius	R	0.45 mm
Size Cross Recess		H2
Penetration Depth	t	2.04 - 2.67 mm
Thread		STS
Weight		2.004 kg / 1000 pieces
Customs Tariff No		73 181 410