

Detalii tehnice STP33A0500120S

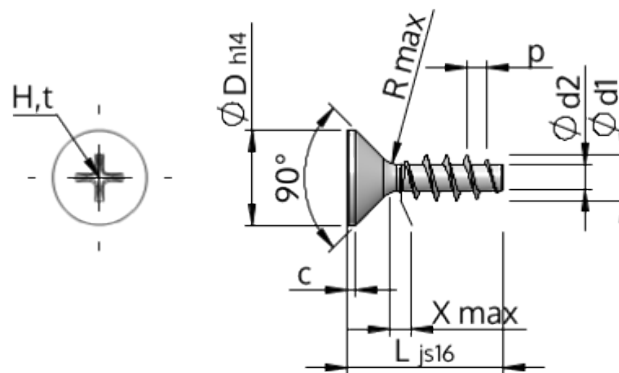

| | | |
|-----------------------------------|-----------|---|
| Numărul articolului | | STP33A0500120S |
| Norma | | KN1033 |
| Material | | oțel, călit |
| Exterior | | zincat 5-7 μm , repect, pasivat transparent/albastru |
| Diametrul exterior al filetului-Ø | d1 | 5.00 $^{+0.18}$ mm |
| Diametru șurub | d2 | 2.68 mm |
| Pasul filetului | p | 2.24 mm |
| Lungimea | L | 12.00 ± 0.55 mm |
| Diametrul capului-Ø | D | 9.30 $_{-0.36}$ mm |
| Cap cilindric | C | 0.75 mm |
| Tija | X | 2.50 mm |
| Radius | R | 0.45 mm |
| Dimensiune Locaș Cruciform | | H2 |
| Adâncimea de penetrării | t | 2.04 - 2.67 mm |
| Fir | | STS |
| Greutate | | 1.412 kg / 1000 unități |
| Tariful vamal nr. | | 73 181 499 |