

Detalii tehnice STP33A0400350S

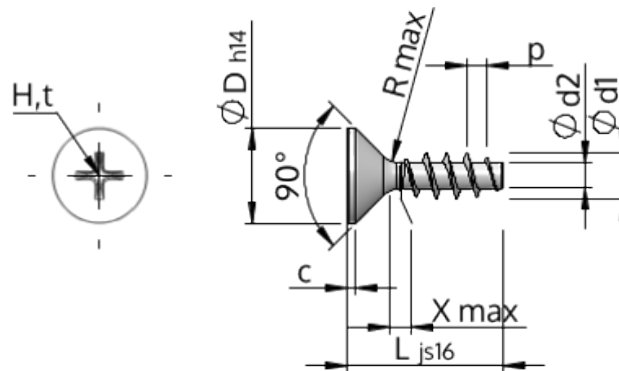

Numărul articolului		STP33A0400350S
Norma		KN1033
Material		oțel, călit
Exterior		zincat 5-7 μm , repect, pasivat transparent/albastru
Diametrul exterior al filetului-Ø	d1	4.00 $^{+0.18}$ mm
Diametru șurub	d2	2.17 mm
Pasul filetului	p	1.79 mm
Lungimea	L	35.00 ± 0.80 mm
Diametrul capului-Ø	D	8.40 $_{-0.36}$ mm
Cap cilindric	C	0.70 mm
Tija	X	2.00 mm
Radius	R	0.40 mm
Dimensiune Locaș Cruciform		H2
Adâncimea de penetrării	t	1.59 - 2.22 mm
Fir		STS
Greutate		2.156 kg / 1000 unități
Tariful vamal nr.		73 181 499