

Spec Sheet STP33A0400350B

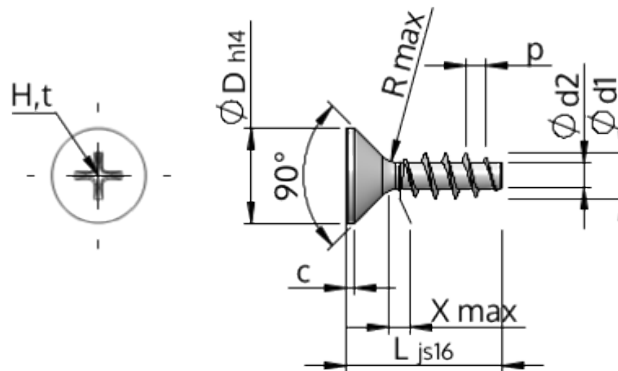

Item Number		STP33A0400350B
Standard		KN1033
Material		steel, hardened
Surface		Zinc-Nickel-plated min. 5µm, passivated black/ Cr-VI-free, baked, sealed
Thread Outside-Ø	<b>d1</b>	4.00 <sup>+0.18</sup> mm
Thread Core-Ø	<b>d2</b>	2.17 mm
Thread Pitch	<b>p</b>	1.79 mm
Length	<b>L</b>	35.00 ±0.80 mm
Head-Ø	<b>D</b>	8.40 <sub>-0.36</sub> mm
Cylindrical Head Height	<b>C</b>	0.70 mm
Thread Run-Out	<b>X</b>	2.00 mm
Radius	<b>R</b>	0.40 mm
Size Cross Recess		H2
Penetration Depth	<b>t</b>	1.59 - 2.22 mm
Thread		STS
Weight		2.156 kg / 1000 pieces
Customs Tariff No		73 181 499